



AREA HEATER

Model No. AH10690DS, AH10600DS

- The ideal solution for extending the season of outdoor entertaining
- Creates a stylish and attractive ambience
- Direct ignition
- Includes a safety 'tip-over' switch that halts supply of gas to the unit should it be accidentally knocked over
- Oxygen depletion system for enhanced safety
- Stainless steel burner for extra long-term reliability
- Complete with hose and POL regulator
- Efficient and powerful 27.5MJ/h output
- Adjustable heat output
- Operates for approximately 17 hours on a properly filled 9Kg Propane cylinder
- For outdoor use only
- Gas certified to Australian standards



FOR YOUR SAFETY

If you smell gas:

1. Shut off the gas to the appliance.
2. Extinguish any open flame.
3. If odour continues, immediately call your gas supplier.

Do not store or use gasoline or other flammable vapour and liquids in the vicinity of this or any other appliance.

WARNING

Improper installation, adjustment, alteration, service or maintenance can cause injury or property damage.

Read the instructions thoroughly before installing or servicing this equipment.

FOR OUTDOOR USE ONLY PROPANE GAS

Important: Retain these instructions for future use.

Installation, Operation and Maintenance Instructions

INSTALLATION

Important Safety Rules

This appliance must only be used in a well ventilated area.

1. This appliance shall not be installed or used indoors, in buildings, garages or any other enclosed area.
2. **DO NOT** place articles on or against this appliance.
3. **DO NOT** use or store flammable materials near this appliance.
4. Children and adults should be alerted to the hazards of high surface temperatures, burns and clothing ignition.
5. Children should be carefully supervised when they are in the area of the appliance.
6. **NEVER** hang anything including clothes or other flammable items on the appliance.
7. **DO NOT** operate this appliance unless it is fully assembled with burner guard in place.
8. **DO NOT SPRAY AEROSOLS IN THE VICINITY OF THIS APPLIANCE WHILE IT IS IN OPERATION.**
9. Installation and repair should be done by a qualified service person. The appliance must be inspected before use and at least annually by a qualified service person. It is imperative that control compartment, burners and circulating air passages of the heater be kept clean.

Prior to assembling your appliance, the following must be reviewed. Compliance with the following should result in satisfactory heater operation. This instruction manual should be retained for future reference. The installation must conform with local codes or authority having jurisdiction.

1. The patio heater is intended for heating residential and non-residential outdoor spaces. The installation must conform with local codes and with the Australian Standard AS/NZS 5601.
2. Adequate clearance around air openings into the combustion chamber, clearances from combustible materials, provisions for accessibility and for combustion and ventilating air supply must be maintained at all times when the appliance is operating.

3. Proper clearance from combustible materials must be maintained at all times. The minimum clearances are as follows:

Minimum Clearance from Combustibles:

Side	500 mm	Rear	500 mm
Ceiling	1000 mm		

Combustible materials are considered to be wood, compressed paper, plant fibres, plastic, plexiglas or other materials capable of being ignited and burned.

Such materials shall be considered combustible even though flame proofed, fire-retardant treated or plastered. Additional clearance may be required for glass, painted surfaces and other materials which may be damaged by radiant or convection heat.

4. Heaters must be placed on a level and adequate footing and be readily accessible.
5. The gas manifold supply pressure must be regulated at 2.75 kPa utilising an AGA approved regulator (supplied with heater).
6. The appliance must be inspected before each use, and at least annually by a qualified service person.
 - a. The appliance area must be kept clear and free of combustible materials, gasoline and other flammable vapours and liquids.
 - b. Gas orifices and burner must be kept clear of dirt and cobwebs. Flow of combustion and ventilation air through the perforated portions of the heater must not be obstructed. Cleaning with a soft brush before use and at least every six months is recommended.
 - c. All gas connections should be checked for leaks utilising a soap solution. Never use a flame for this purpose.
 - d. The flame pattern should be visually checked whenever heater is operated. If flames extend beyond surface of the guard the appliance should be turned off and should not be operated again until the unit is serviced and or repaired.
 - e. Any cleaning agent used on the heater should be of a non-combustible and non-corrosive nature.
 - f. The stainless steel emitter normally does not require cleaning and should **NEVER** be painted.

7. The hose must be protected from contact with hot or sharp surfaces both during use and while in storage. The hose assembly should be visually inspected prior to each use of the heater. If excessive abrasion or wear is evident, or the hose is cut, it must be replaced prior to operating the heater. The replacement hose assembly may be obtained from the manufacturer.
8. **DO NOT** use any pressure regulator or hose assembly other than those supplied with the appliance. Replacement pressure regulator and hose assembly must be those specified. Replacement parts may be obtained from the manufacturer or your local sales representative.
9. Installation and use of this heater must conform with local codes and AS/NZS 5601.
10. This heater is designed to operate with a standard 9Kg propane cylinder with Approved Cylinder Connection.
11. The valve outlet must be maintained in good condition. When the cylinder is not in use, be sure to cover it with a dust cap. A leak test should be performed with soapy water whenever connecting a new cylinder. **NEVER** use a match to test for leaks.
12. The propane cylinder must be turned off whenever the heater is not in use. When the heater is to be stored indoors, the propane cylinder and the heater must be disconnected and the cylinder stored in accordance with the Standard for Storage and Handling of Liquefied Gases.
13. The appliance has been designed with several safety features which include a tip over switch.

Any modification to the heater not described in the installation instructions may compromise the safety of this appliance. Special concern is as follows:

- (1) **DO NOT** bypass thermocouple safety burner;
- (2) **DO NOT** operate heater without the guard;

Clothing or other flammable materials should not be hung from the heater, or placed on or near the heater. The area above the burner may be extremely hot. Direct contact with these metal surfaces should be avoided in order to prevent burns or clothing ignition.

POL CYLINDER CONNECTION DEVICE

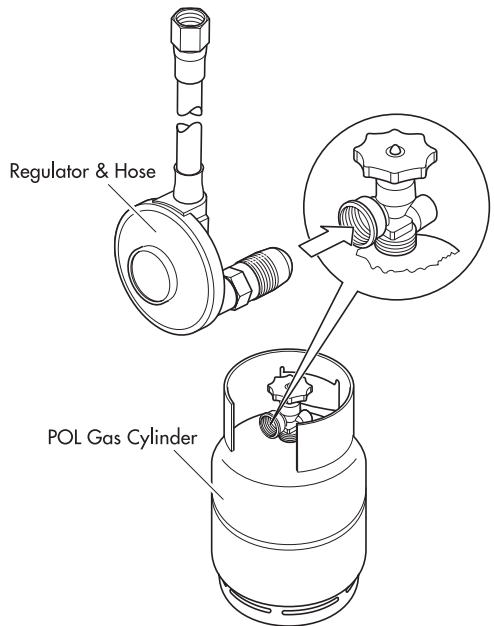

Screw the coupling nut of regulator into the cylinder valve outlet.



IMPORTANT

Storage of an appliance indoors with the cylinder attached is only permitted if the size of the cylinder complies with AS/NZS 1596; otherwise cylinders must be stored outdoors in a well ventilated area.

The guards are fitted to this appliance to reduce the risk of fire or injury from burns and no part of it should be removed.

This appliance must be protected from exposure to rain.

Type of Gas	Propane
Consumption	27.5 MJ/h
Operating Pressure	2.75 kPa
Injector Size	1.48 mm

Heater specifications can be found on the data label.

AREA HEATER ASSEMBLY

Tools Required

Phillips head screwdriver, 2 Adjustable spanners

Note: Remove any transit protection material

STEP 1

Attach the brackets onto the base with four M8 x 16mm bolts, then attach the cylinder cover with eight M5 x 10mm screws and nuts.

STEP 2

Place the burner head on the cylinder cover and secure with four M4 x 8mm screws.

STEP 3

Position the mesh guard around the burner with the lift up door in front of the control knob locating the wire pins into the cylinder cover holes then secure with the wing nut on top.

STEP 4

Attach the hose and regulator to the underside of the burner head, tightening the hose fitting thread firmly. Leak test this connection with a soapy water solution before attempting to light the heater.

PARTS LIST	
NAME	QTY
Mesh Guard	2
Burner Head	1
Cylinder Cover	1
Hose and Regulator	1
Base	1
Base Brackets	4
Wing Nut	1
M8 x 16mm Bolt	6
M8 Nut	2
M5 x 10mm Screws & Nuts	8
M4 x 8mm Screws	4

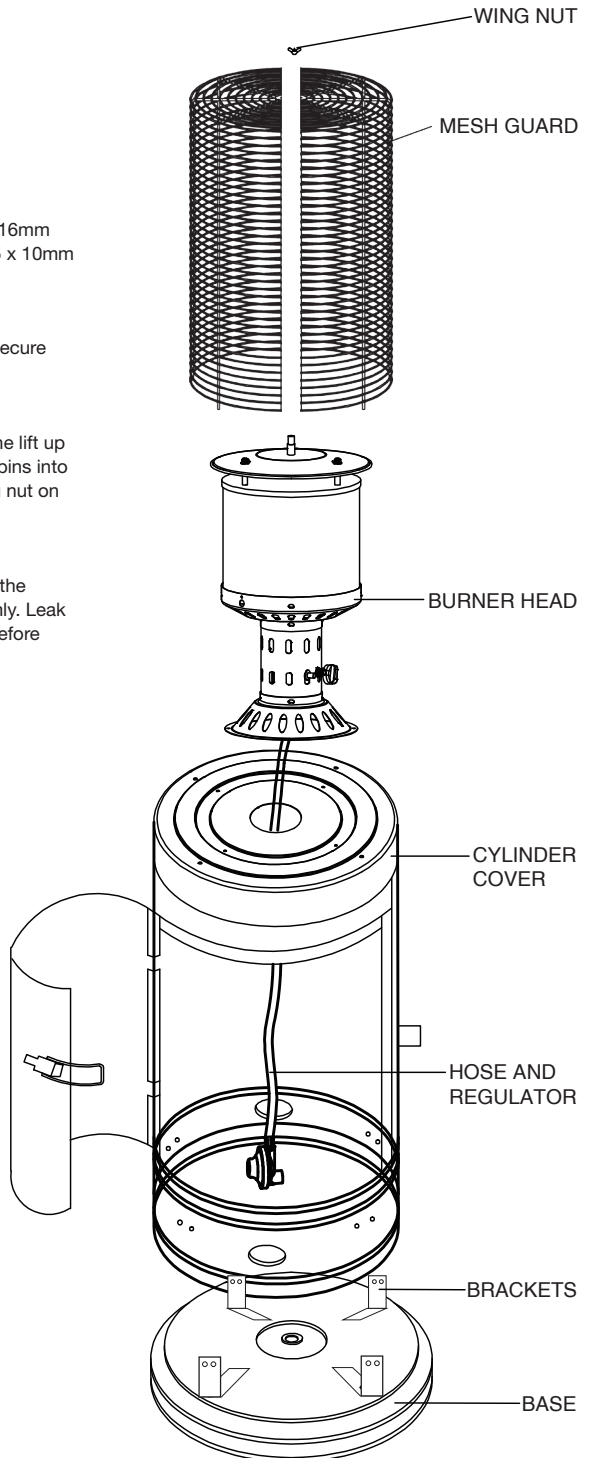

AREA HEATER - For Outdoor Use Only

Minimum Clearance from Combustible Surfaces*:

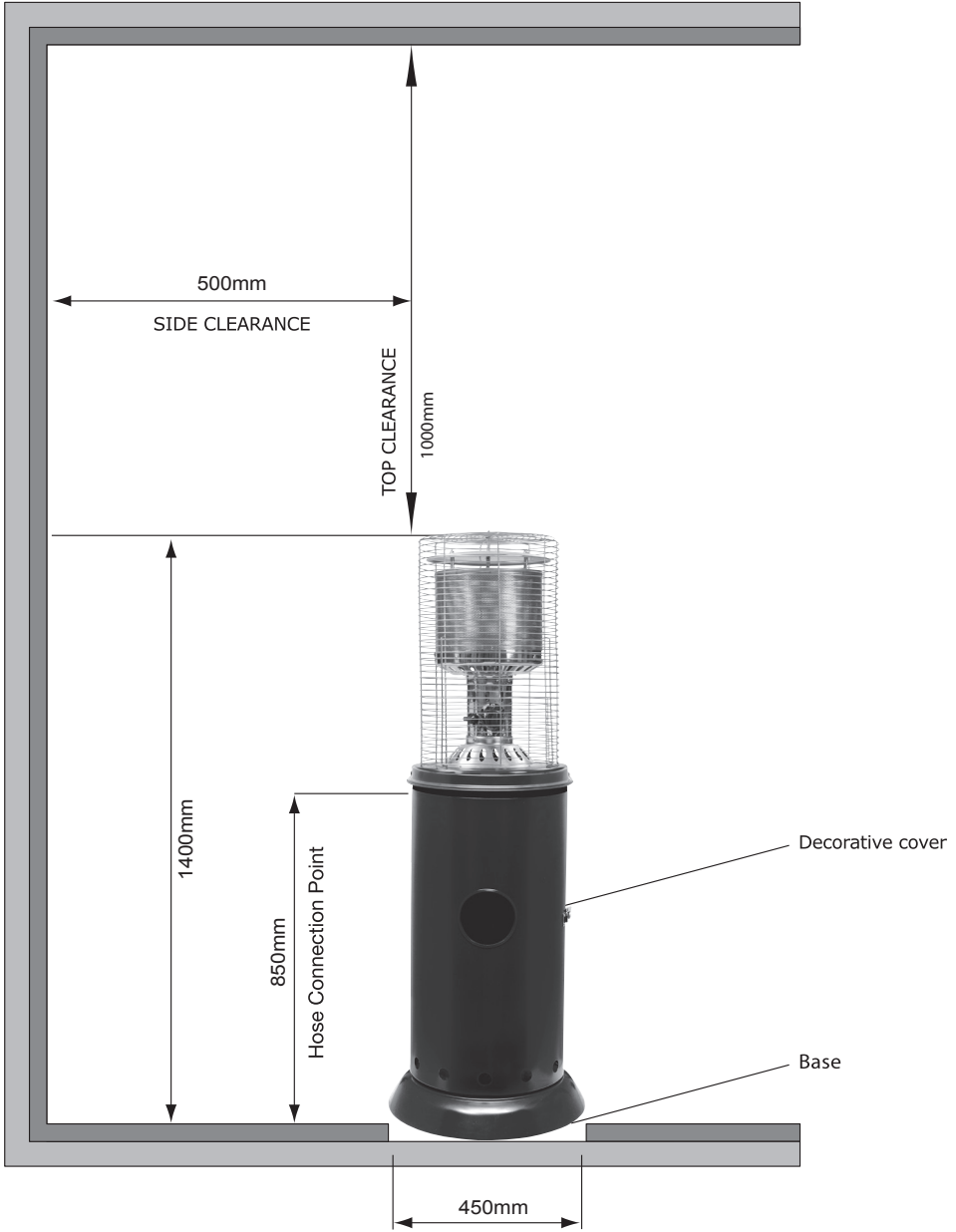

*Combustible materials are considered to be wood, compressed paper, plant fibres, plastic or other materials that are capable of being ignited and burned.

TEST FIRING HEATER

Test fire heater, following the lighting instructions. Leak test all gas connections with soapy water. Soap bubbles indicate gas leakage. DO NOT use a match to test for gas leaks.

TROUBLE SHOOTING

Problem	Possible Causes	Solution
Main burner will not light	No gas	Replace cylinder
	Low gas pressure	Replace cylinder
	Blockage in orifice	Remove blockage
	Manual valve no in LOW or HIGH position	Position to HIGH
	Exposure to rain	Remove emitter and clean burner ports

Note: If the appliance cannot be adjusted to perform correctly it should not be used until serviced or repaired.

LIGHTING INSTRUCTIONS

1. Ensure that the control knob is off. Slowly open the gas cylinder valve.
2. Push in control knob and turn anti-clockwise to LO whilst simultaneously pressing the red ignitor button.
3. Check for flame at the burner. If burner does not light immediately turn control knob to OFF position and try again from the start. Allow 30 seconds between ignition attempts for gas to dissipate. Several attempts may be necessary.

Failure to follow this lighting procedure may result in flame roll out beyond the emitter grid.

4. With the burner alight keep control knob depressed for 15 seconds.
5. For maximum heat push in and turn the control knob to HI.
6. To turn heater off, turn the control knob to OFF.

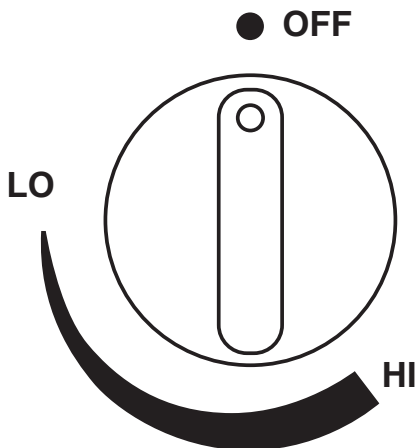

WARNING

White smoke may appear around the emitter grid during the first minute of initial firing.

Improper installation, adjustment, alteration, service or maintenance can cause injury or property damage.

Any modifications or adjustments made to product without prior authority from the manufacturer will void any warranty claims. Read the installation, operating and maintenance instructions thoroughly before installing or servicing this equipment.

SAFE APPLIANCE LOCATIONS

This appliance shall only be used in an above ground open-air situation with natural ventilation, without stagnant areas, where gas leakage and products of combustion are rapidly dispersed by wind and natural convection.

Any enclosure in which the appliance is used shall comply with the following:

An enclosure with walls on all sides, but at least one permanent opening at ground level and no overhead cover (see Example 1).

Within a partial enclosure that includes an overhead cover and no more than two walls (see Example 2 & 3).

Within a partial enclosure that includes an overhead cover and more than two walls, the following will apply:

At least 25% of the total wall area is completely open, and
at least 30% of the remaining wall area is open and unrestricted.

In the case of balconies, at least 20% of the total wall area shall be and remain open and unrestricted (see Example 4 & 5).

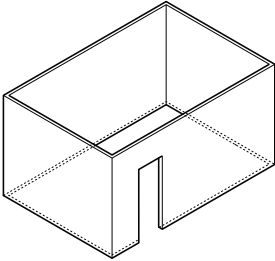

Outdoor Area - Example 1

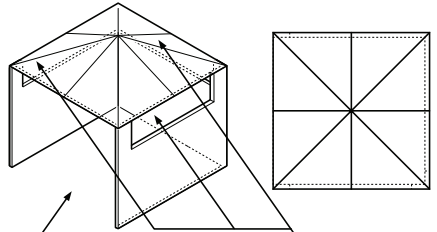
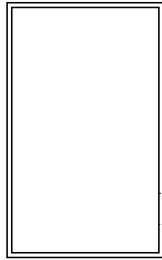

Open Side at least 25% of total wall area

30% or more in total of the remaining wall area is open and unrestricted

Outdoor Area - Example 4

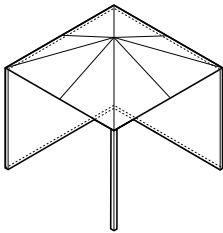
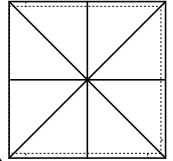

Outdoor Area - Example 2

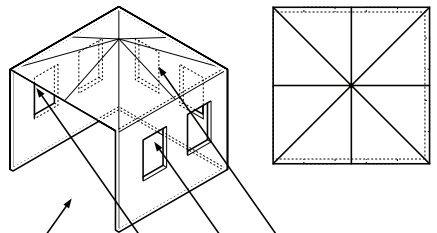
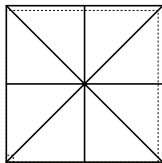

Open Side at least 25% of total wall area

30% or more in total of the remaining wall area is open and unrestricted

Outdoor Area - Example 5

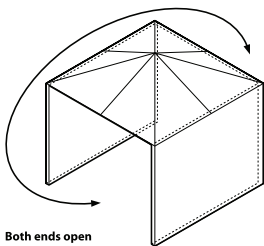
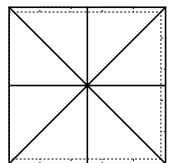

Both ends open

Outdoor Area - Example 3

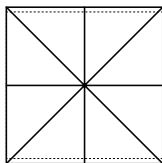

For any queries or assistance call



Customer Service
(Australia Only)

1300 174 876

Hours of operation:
Monday to Friday 8am - 5pm EST

Do not return to place of purchase.
Keep your purchase receipt, this will be required to
make any claims under the 12 month warranty.