



THE OUTDOORS MADE EASY



SPECIALIST DELUXE SERIES II

The Specialist Deluxe Series II features a contemporary and stylish design while still delivering all the fabulous cooking results you have come to expect from Gasmate.





SPECIALIST



DELUXE SERIES II

Standard Features

SPECIALIST DELUXE SERIES II



- PREMIUM VITREOUS ENAMEL BODY
- STYLISH CABINET WITH GLASS DOORS
- #304 GRADE STAINLESS STEEL HOOD AND FASCIA
- GLASS VIEWING WINDOW
- TEMPERATURE GAUGE, COOL TOUCH HANDLE AND WARMING RACK
- CONVENIENT INTERNAL LIGHTS AND BLUE LED'S ON CONTROL KNOBS
- POWERFUL INTEGRATED HIGH OUTPUT SIDE BURNER
- ELECTRONIC IGNITION FOR EFFORTLESS LIGHTING
- SATIN ENAMEL CAST IRON GRILL AND REVERSIBLE PLATE
- CAST IRON BURNERS WITH INDIVIDUAL CONTROLS
- CAST IRON FLAME TAMER WITH CERAMIC BRIQUETTES FOR EVEN HEAT DISTRIBUTION
- 4 CASTORS (2 LOCKING)
- IAPMO OCEANA CERTIFIED
- CERTIFIED FOR NATURAL GAS CONVERSION

COOKING SURFACE

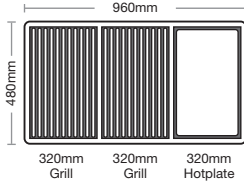

Deluxe Side Burner and Internal Lights



SPECIALIST DELUXE SERIES II
6 BURNER BBQ

MODEL NO.
BQ8362

- Powerful combined output 101.6MJ/h (6 x 14.6MJ/h burners + 14MJ/h side burner)
- Supplied with hose and regulator
- DIMENSION **1730mm W x 600mm D x 1200mm H**



SPECIALIST DELUXE SERIES II
4 BURNER BBQ

MODEL NO.
BQ8342

- Powerful combined output 72.4MJ/h (4 x 14.6MJ/h burners + 14MJ/h side burner)
- Supplied with hose and regulator
- DIMENSION **1550mm W x 600mm D x 1200mm H**

COOKING SURFACE

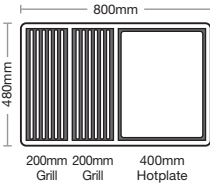

Deluxe Side Burner and Internal Lights

Built-In SPECIALIST DELUXE SERIES II



- PREMIUM VITREOUS ENAMEL BODY
- #304 GRADE STAINLESS STEEL HOOD AND FASCIA
- GLASS VIEWING WINDOW
- TEMPERATURE GAUGE, COOL TOUCH HANDLE AND WARMING RACK
- CONVENIENT INTERNAL LIGHTS AND BLUE LED'S ON CONTROL KNOBS
- ELECTRONIC IGNITION FOR EFFORTLESS LIGHTING
- SATIN ENAMEL CAST IRON GRILL AND REVERSIBLE PLATE
- CAST IRON BURNERS WITH INDIVIDUAL CONTROLS
- CAST IRON FLAME TAMER WITH CERAMIC BRIQUETTES FOR EVEN HEAT DISTRIBUTION
- IAPMO OCEANA CERTIFIED
- CERTIFIED FOR NATURAL GAS CONVERSION





SPECIALIST DELUXE SERIES II
BUILT-IN 6 BURNER BBQ

MODEL NO.
BQ8362B

- Powerful combined output 87.6MJ/h (6 x 14.6MJ/h burners)
- Supplied with hose and regulator
- DIMENSION **1010mm W x 600mm D x 500mm H**



Deluxe Internal Lights

COOKING SURFACE

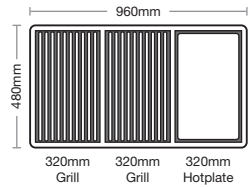

SPECIALIST DELUXE SERIES II
BUILT-IN 4 BURNER BBQ

MODEL NO.
BQ8342B

- Powerful combined output 58.4MJ/h (4 x 14.6MJ/h burners)
- Supplied with hose and regulator
- DIMENSION **840mm W x 600mm D x 500mm H**



Deluxe Internal Lights

COOKING SURFACE

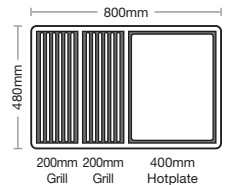



Modules **SPECIALIST DELUXE** SERIES II

The Gasmate Specialist Deluxe Series II Modules have been designed to complement your Specialist BBQ, creating a fantastic outdoor cooking area quickly and easily.





Modules

SPECIALIST DELUXE SERIES II



SPECIALIST DELUXE SERIES II
STORAGE MODULE

MODEL NO.
BQ8302

Marble top with powder coated body

- DIMENSION 845mm W x 575mm D x 880mm H



BLACK GLASS DOORS



FULL WIDTH #304 STAINLESS STEEL
DRAWER AND FASCIA



4 CASTORS (2 LOCKING)



FREESTANDING UNIT



SOFT CLOSING DRAWER



Interchangeable sink – top can be moved from left to right depending on your kitchen layout (1)



SPECIALIST DELUXE SERIES II
SINK MODULE

MODEL NO.
BQ8301

Marble top with powder coated body

- DIMENSION 845mm W x 575mm D x 880mm H



BLACK GLASS DOORS



#304 STAINLESS STEEL SINK WITH WELS
FLICK TAP AND FASCIA



4 CASTORS (2 LOCKING)



FREESTANDING UNIT



WELS APPROVED HOT AND COLD TAP





SPECIALIST DELUXE SERIES II BREAKFAST CART

**MODEL NO.
BQ8322**

3 Burner breakfast cart • Powerful combined output
41.1MJ/h

(3 x 13.7MJ/h burners)

• DIMENSION **845mm W x 590mm D x 880mm H**

SINGLE SATIN ENAMEL CAST RAIL BURNER
WITH SATIN ENAMEL HOTPLATE



DUAL CAST BRASS CAP BURNERS WITH
CAST IRON TRIVET



LED CONTROL KNOBS



STYLISH CABINET WITH GLASS DOORS
AND #304 STAINLESS STEEL FASCIA



ELECTRONIC IGNITION



4 CASTORS (2 LOCKING)



FREESTANDING UNIT



OPERATES ON UNIVERSAL LPG



IAPMO OCEANA CERTIFIED



CERTIFIED FOR CONVERSION TO
NATURAL GAS



*plus*Fridge



**1 DOOR
BAR FRIDGE 118L**

**MODEL NO.
GMF118D**

- Supplied fully assembled
- Single door compressor refrigerator
- Elegant #430 grade brushed stainless steel exterior finish
- Low noise operation
- Adjustable thermostat
- Magnetic door seal and adjustable feet
- Double glazed glass door with lock
- Elegant #304 grade mirror stainless steel interior finish
- Tested and approved to Australian Standards*
- DIMENSION **503mm W x 503mm D x 850mm H**



**SPECIALIST DELUXE SERIES II
SINGLE DOOR FRIDGE TOP**

**MODEL NO.
BQ8307**



Double glazed fridge door

SPECIAL TOP for Gasmate 1 Door (118Ltr) Bar Fridge
to bring height of fridge up to the same height as the
Specialist Deluxe Series II BBQ and Modules

- Stainless steel fascia with marble top so that fridge
integrates perfectly into your outdoor kitchen



PROFESSIONAL 120CM PRO RANGEHOOD

MODEL NO.
GRHM

WALL MOUNTED

- 150mm diameter flexible ducting x 2
- Minimum 1200mm from BBQ cooking surface to Rangehood
- Noise level \leq 80 dba
- Weight: 40Kg
- DIMENSIONS **1200mm W x 800mm D**



2000m³/hr EXTRACTION CAPACITY



MARINE GRADE #316 STAINLESS STEEL



STAINLESS STEEL BAFFLE FILTERS



3 SPEED FAN PUSH BUTTON CONTROL SETTINGS



4 X LED LIGHTS, 12V – 1.8W



2 X 1000 WATT MOTORS



WALL MOUNT



PROFESSIONAL 120CM ISLAND PRO RANGEHOOD

MODEL NO.
GMHIS

CEILING MOUNTED / SUSPENDED

- 150mm diameter flexible ducting x 2
- Minimum 1200mm from BBQ cooking surface to Rangehood
- Noise level \leq 80 dba
- Weight: 40Kg
- DIMENSIONS **1200mm W x 800mm D**



2000m³/hr EXTRACTION CAPACITY



MARINE GRADE #316 STAINLESS STEEL



STAINLESS STEEL BAFFLE FILTERS



3 SPEED FAN PUSH BUTTON CONTROL SETTINGS



4 X LED LIGHTS, 12V – 1.8W



2 X 1000 WATT MOTORS



CEILING MOUNT



PROFESSIONAL 148CM PRO RANGEHOOD

MODEL NO.
GRHL

WALL MOUNTED

- 150mm diameter flexible ducting x 3
- Minimum 1200mm from BBQ cooking surface to Rangehood
- Noise level \leq 90 dba
- Weight: 62Kg
- DIMENSIONS **1480mm W x 800mm D**



3000m³/hr EXTRACTION CAPACITY



MARINE GRADE #316 STAINLESS STEEL



STAINLESS STEEL BAFFLE FILTERS



3 SPEED FAN PUSH BUTTON CONTROL SETTINGS



6 X LED LIGHTS, 12V – 1.8W



3 X 1000 WATT MOTORS



WALL MOUNT





Range Hoods

SPECIALIST DELUXE SERIES II



HIGH POWERED FANS



**STAINLESS STEEL
BAFFLE FILTERS**



LED DOWN LIGHTS



SPECIALIST DELUXE SERIES II
BUILT-IN 4 BURNER BBQ

MODEL NO.
BQ8342B



SPECIALIST DELUXE SERIES II
6 BUILT-IN BURNER BBQ

MODEL NO.
BQ8362B

Built-In Barbecue Dimensions (4 Burner illustrated)

I.)

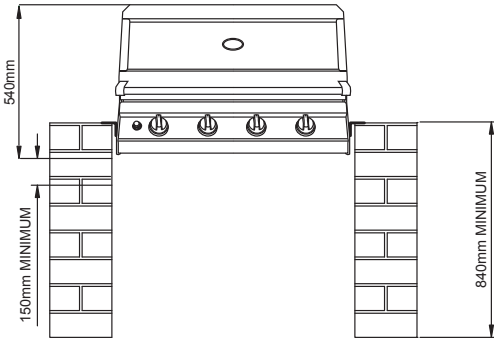

II.)

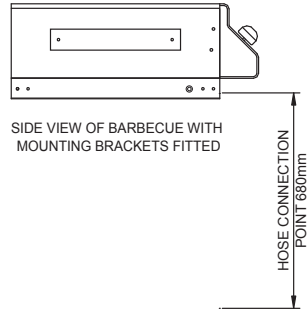

III.)

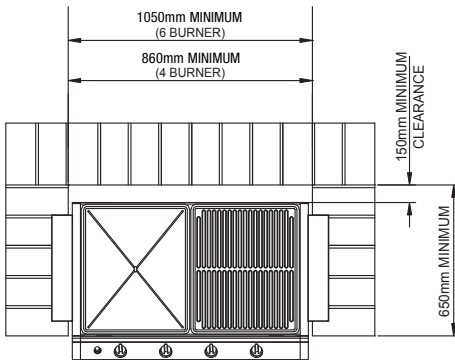

IV.)

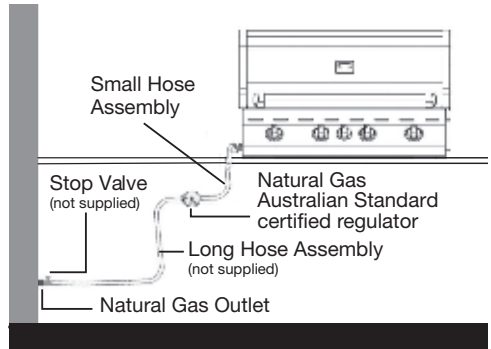

MINIMUM CLEARANCES REQUIRED

60mm at Rear

50mm Below

CUT OUT DIMENSIONS

For built-in installations: islands, masonry, other non-combustible material structures

4B Width: 860mm 6B Width: 1050mm

Height: 450mm

Depth : 650mm

(includes 100mm rear clearance for opening hood)

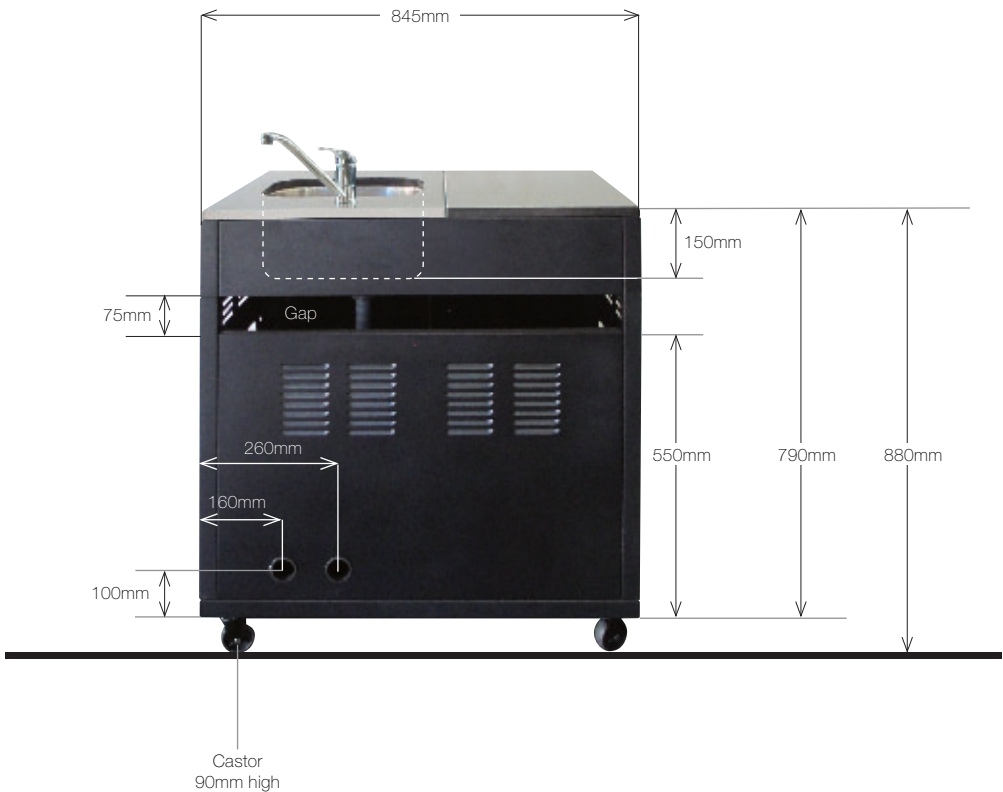

CUT OUT DIMENSIONS

For built-in installations: islands, masonry, other non-combustible material structures

Width: 845mm

Height: 880mm (not including tap)

Depth: 575mm

Every Gasmate barbecue is designed to provide maximum performance and durability. You will find features that make your BBQ perform better, last longer and allow you to enjoy the outdoors much easier.



Satin enamel cast iron grill and reversible hotplate – giving you maximum versatility when cooking. The grill gives you perfect grill marks while the reversible hotplate is grooved to capture juices for continuous basting while cooking.

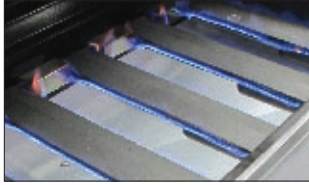

Cast iron burners with individual controls – give a consistent flame from front to back, providing even and efficient heat distribution. The individual controls give you precise heat control, allowing you to set your BBQ to the perfect temperature.



Stylish stainless steel fascia – looks good, easy to clean and the convenient internal lights and LED on knobs will make BBQing easier and you will be the envy of all your friends!



Combination of premium #304 grade stainless steel and black glass – elegant styling mixed with modern simplicity



Useful temperature gauge in the roasting hood allows you keep a precise check on the temperature in the BBQ.

accessories

available to further extend your Specialist BBQ. . .



Rotisserie Kit

Turns your BBQ into a spit roaster



Cover

To keep your BBQ clean, dry and protected from the weather



BBQ Tools

To help you create a fantastic meal

AVAILABLE FROM

Find us on
Facebook 

www.facebook.com/GasmateAustralia

Due to continual product development, the product you purchase may differ slightly from the ones shown here. Gasmate® is a registered trademark of Sitro Group Australia Pty. Ltd. www.gasmate.com.au and AberGas Ltd. Hamilton, N.Z. www.gasmate.co.nz *AS/NZS 60335.2:24

03194 02/15