

PATIO HEATER

Model No. PH2160, PH2165 & PH2169

- The ideal solution for extending the season for outdoor entertaining
- Direct ignition
- Maximum output 40MJ/h
- Adjustable heat output
- Operates for approximately 9 hours on a properly filled 9Kg propane cylinder
- Includes a safety 'tip-over'switch that halts supply of gas to the unit should it be accidentally knocked over
- Flame safeguard system for enhanced safety
- Durable and weather resistant
- Complete with hose and regulator
- For outdoor use only
- Includes hose and regulator
- Certified to Australian standards



FOR YOUR SAFETY

If you smell gas:

1. Shut off the gas to the appliance.
2. Extinguish any open flame.
3. If odour continues, immediately call your gas supplier.

Do not store or use gasoline or other flammable vapour and liquids in the vicinity of this or any other appliance.

FOR OUTDOOR USE ONLY

PROPANE GAS

WARNING

Improper installation, adjustment, alteration, service or maintenance can cause injury or property damage.

Read the instructions thoroughly before installing or servicing this equipment.

Important: Retain these instructions for future use.

INSTALLATION, OPERATION & MAINTENANCE INSTRUCTIONS



IMPORTANT SAFETY RULES

This appliance must only be used in a well ventilated area.

1. This appliance shall not be installed or used indoors, in buildings, garages or any other enclosed area.
2. **DO NOT** place articles on or against this appliance.
3. **DO NOT** use or store flammable materials near this appliance.
4. Children and adults should be alerted to the hazards of high surface temperatures, burns and clothing ignition.
5. Children should be carefully supervised when they are in the area of the appliance.
6. **NEVER** hang anything including clothes or other flammable items on the appliance.
7. **DO NOT** operate this appliance unless it is fully assembled with burner guard in place.
8. **DO NOT SPRAY AEROSOLS IN THE VICINITY OF THIS APPLIANCE WHILE IT IS IN OPERATION.**
9. Installation and repair should be done by a qualified service person. The appliance must be inspected before use and at least annually by a qualified service person. It is imperative that control compartment, burners and circulating air passages of the heater be kept clean.

Prior to assembling your appliance, the following must be reviewed. Compliance with the following should result in satisfactory heater operation. This instruction manual should be retained for future reference. The installation must conform with local codes or authority having jurisdiction.

1. The appliance is intended for heating residential and non-residential outdoor spaces. The installation must conform with local codes or, in the absence of local codes, with the Australian Standard AS 5601.
2. Adequate clearance around air openings into the combustion chamber, clearances from combustible materials, provisions for accessibility and for combustion and ventilating air supply must be maintained at all times when the appliance is operating.
3. Proper clearance from combustible materials must be maintained at all times. The minimum clearances are as follows:

Minimum Clearance from Combustibles

Side	500mm	Rear	500mm
Ceiling	500mm	Below	1800mm

Combustible materials are considered to be wood, compressed paper, plant fibres, plastic, plexiglas or other materials capable of being ignited and burned. Such materials shall be considered combustible even though flame proofed, fire-retardant treated or plastered. Additional clearance may be required for glass, painted surfaces and other materials which may be damaged by radiant or convection heat.

4. Heaters must be placed on a level and adequate footing and be readily accessible.
5. The gas manifold supply pressure must be regulated at 2.75 kPa utilising an AGA approved regulator (supplied with heater).
6. The appliance must be inspected before each use, and at least annually by a qualified service person.
 - a. The appliance area must be kept clear and free of combustible materials, gasoline and other flammable vapours and liquids.
 - b. Gas orifices and burner must be kept clear of dirt and cobwebs. Flow of and ventilation air through the perforated portions of the heater must not be obstructed. Cleaning with a soft brush before use and at least every six months is recommended.
 - c. All gas connections should be checked for leaks utilising a soap solution.
NEVER use a flame for this purpose.

For any queries or assistance call



Customer Service

Australia Only

1300 174 876

Hours of operation:

Monday to Friday 8.30am - 5.30pm EST

Do not return to place of purchase.

INSTALLATION - OUTDOOR USE ONLY

- d. The flame pattern at the emitter grid should be visually checked whenever heater is operated. If flames extend beyond surface of the emitter grid or black spot is accumulating on the emitter grid or reflector, the heater should be turned off immediately.
The heater should not be operated again until the unit is serviced and or repaired.
 - e. Any cleaning agent used on the heater should be of a non-combustible and non-corrosive nature.
 - f. The stainless steel emitter grid normally does not require cleaning and should **NEVER** be painted.
7. The hose assembly should be located out of pathways where people may trip over it. The hose must be protected from contact with hot or sharp surfaces both during use and while in storage. The hose assembly should be visually inspected prior to each use of the heater. If excessive abrasion or wear is evident, or the hose is cut, it must be replaced prior to operating the heater. The replacement hose assembly may be obtained from the manufacturer.
 8. **DO NOT** use any pressure regulator or hose assembly other than those supplied with the appliance. Replacement pressure regulator and hose assembly must be those specified. Replacement parts may be obtained from the manufacturer or your local sales representative.
 9. Installation and use of this heater must conform with local codes or, in the absence of local codes, with the Standards of Storage and Handling of Liquefied Petroleum Gases.
 10. This heater is designed to operate with a standard 9Kg propane cylinder with Approved Cylinder Connection.
 11. The valve outlet must be maintained in good condition. When the cylinder is not in use, be sure to cover it with a dust cap. A leak test should be performed with soapy water whenever connecting a new cylinder. **NEVER** use a match to test for leaks.
 12. The gas cylinder must be turned off whenever the heater is not in use. When the heater is to be stored indoors, the propane cylinder and the heater must be disconnected and the cylinder stored in accordance with the Standard for Storage and Handling of Liquefied Gases.

13. The heater has been designed with several safety features which include a tip over switch.

NOTE: The plastic container in the base must be filled with sand before use.

Any modification to the heater not described in the installation instructions may compromise the safety of this appliance. Special concern is as follows:

- (1) **DO NOT** shorten post length;
- (2) **DO NOT** bypass thermocouple safety;
- (2) **DO NOT** operate heater without the reflector;

Clothing or other flammable materials should not be hung from the heater, or placed on or near the heater. The area above the burner may be extremely hot. Direct contact with these metal surfaces should be avoided in order to prevent burns or clothing ignition.

POL CYLINDER CONNECTION DEVICE

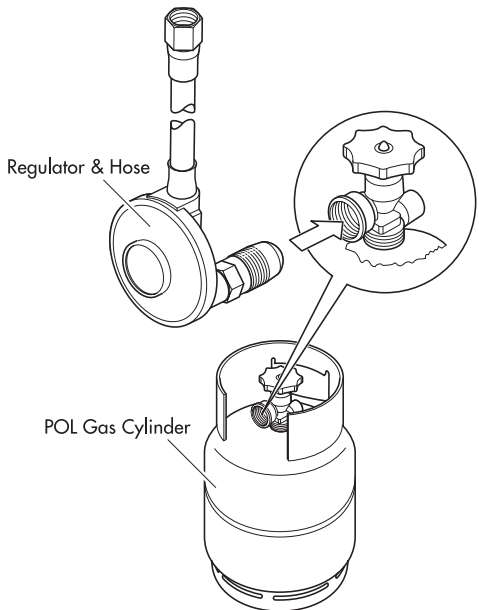

Screw the coupling nut of regulator into the cylinder valve outlet.

Type of Gas	Propane
Consumption	40 MJ/h
Operating Pressure	2.75 kPa
Injector Size	1.9 mm

Heater specifications can be found on the data label.

PATIO HEATER - FOR OUTDOOR USE ONLY

Minimum Clearance from Combustible Surfaces*:

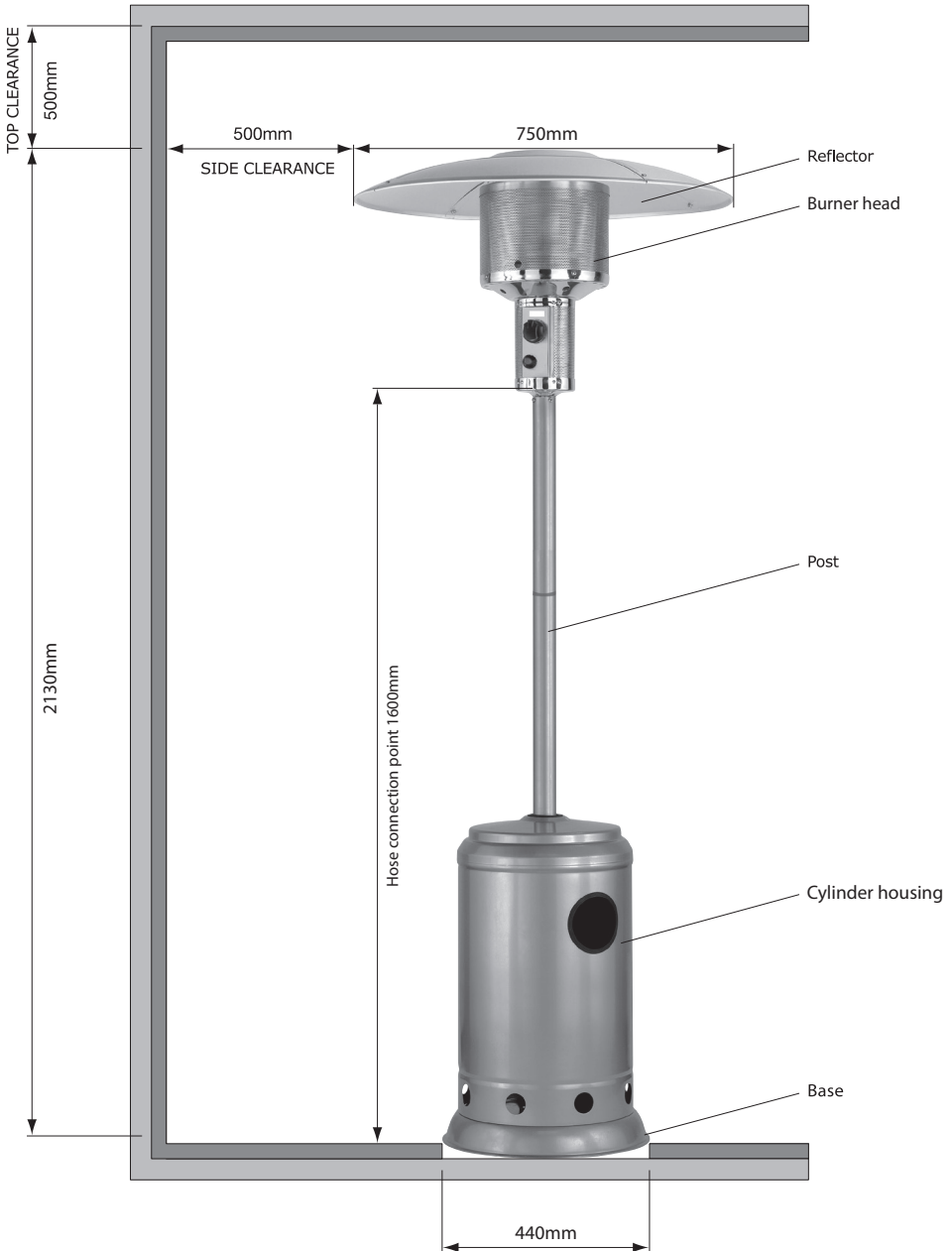

*Combustible materials are considered to be wood, compressed paper, plant fibres, plastic or other materials that are capable of being ignited and burned.

REFLECTOR ASSEMBLY

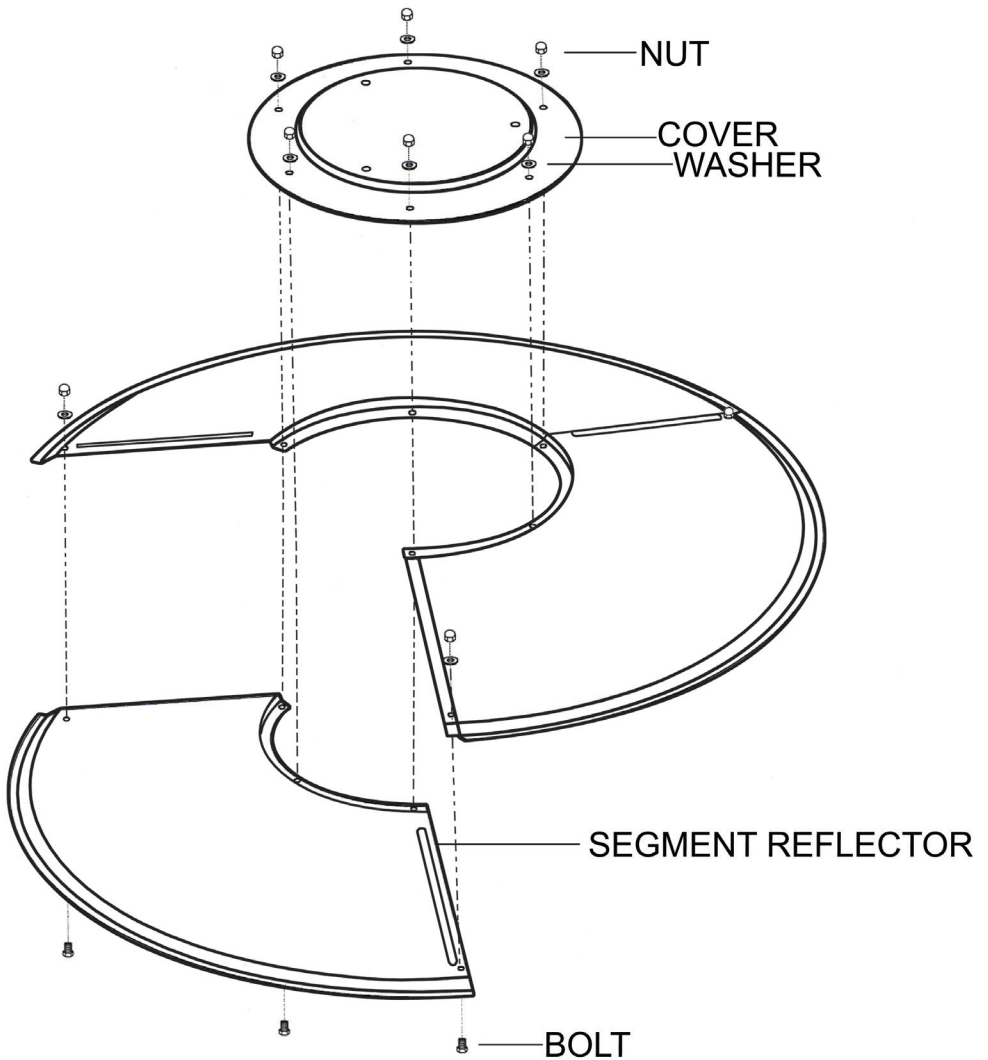

1. Place the 3 parts of reflector segments to overlap together and attach with 3 screws, washers and nuts.
2. Place round part of reflector over the 3 segments and attach with 6 screws, washers and nuts.

ASSEMBLY INSTRUCTIONS

Note: Remove any transit protection material.

Tools required

Adjustable spanner.

Step 1

- 1-1. Put the 3 post brackets on each position on the base as shown in the picture.
- 1-2. Use 3 M8 x 16mm bolts to join the post brackets and base.

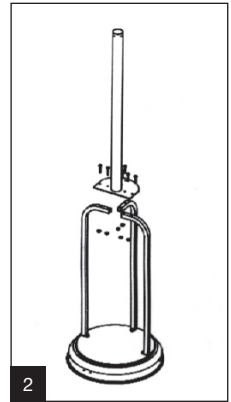
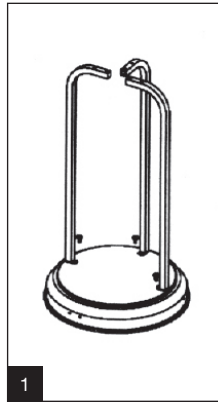

Step 2

- 2-1. Put the base post on the top of 3 post brackets.
- 2-2. Use 6 M6 x35mm bolts and nuts to connect the post to the post brackets. Tighten the bolts and nuts.
- 2-3. Fill the plastic container in the base with sand.
- 2-4. Attach the top post using 4M6 screws.

Step 3

Place the cylinder housing on the stand.

Step 4

- 4-1. Secure the 3 90mm pins (reflector support bolts) on the cap of flame screen.
- 4-2. Route the gas hose up through the post and out of the top.
- 4-3. Connect the gas hose to the gas burner inlet connector.
- 4-4. Connect the regulator to the hose and a gas cylinder and leak test both of the connections using a soapy water solution.
- 4-5. Attach the completed burner to the post with 4 M6 x 10mm bolts.

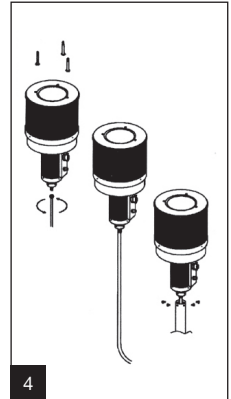
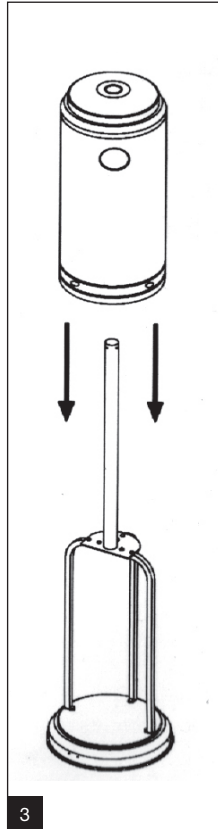

Step 5

- 5-1. Place a washer on each reflector support bolt.
- 5-2. Fasten the reflector with 3 washers and 3 M8 castle nuts.

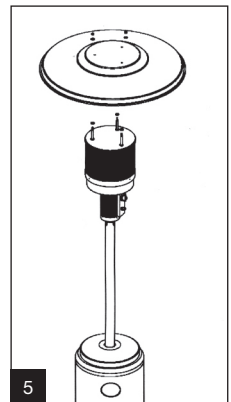

TEST FIRING HEATER

Test fire heater, following the lighting instructions on heater post. Leak test all gas connections with soapy water. Soap bubbles indicate gas leakage. **DO NOT** use a match to test for gas leaks.

TROUBLE SHOOTING

Problem	Possible Causes
Main burner will not light	No gas
	Low gas pressure
	Blockage in orifice
	Manual valve no in LOW or HIGH position

Note: If the appliance cannot be adjusted to perform correctly it should not be used until serviced or repaired.

LIGHTING INSTRUCTIONS

Step 1

Ensure that the control knob is off. Slowly open the gas cylinder valve.

Step 2

Push in control knob and turn anti-clockwise to HIGH whilst simultaneously pushing the ignitor button several times.

Step 3

Check for flame at the burner. If burner does not light immediately turn control knob to OFF position and try again from the start. Allow 30 seconds between ignition attempts for gas to dissipate. Several attempts may be necessary.

Failure to follow this lighting procedure may result in flame roll out beyond the emitter grid.

Step 4

With the burner alight keep control knob depressed for 15 seconds.

Step 5

For minimum heat push in and turn the control knob to LOW.

Step 6

To turn heater off, turn the control knob to OFF.

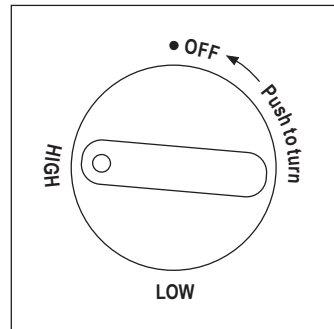
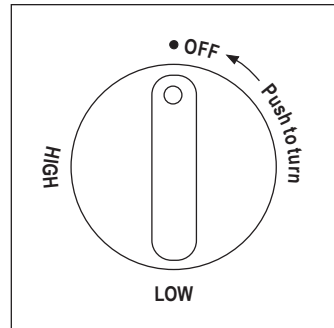

WARNING

White smoke may appear around the emitter grid during the first minute of initial firing.

Improper installation, adjustment, alteration, service or maintenance can cause injury or property damage. Any modifications or adjustments made to product without prior authority from the manufacturer will void any warranty claims. Read the installation, operating and maintenance instructions thoroughly before installing or servicing this equipment.

SAFE APPLIANCE LOCATIONS

This appliance shall only be used in an above ground open-air situation with natural ventilation, without stagnant areas, where gas leakage and products of combustion are rapidly dispersed by wind and natural convection.

Any enclosure in which the appliance is used shall comply with one of the following:

An enclosure with walls on all sides, but at least one permanent opening at ground level and no overhead cover (see Example 1).

Within a partial enclosure that includes an overhead cover and no more than two walls (see Example 2 & 3).

Within a partial enclosure that includes an overhead cover and more than two walls, the following will apply:

at least 25% of the total wall area is completely open, and

at least 30% of the remaining wall area is open and unrestricted (see Example 4 & 5).

In the case of balconies, at least 20% of the total wall area shall be and remain open and unrestricted.

The following figures are diagrammatical representations of outdoor areas. Rectangular areas have been used in these figures - the same principles apply to any other shaped area.

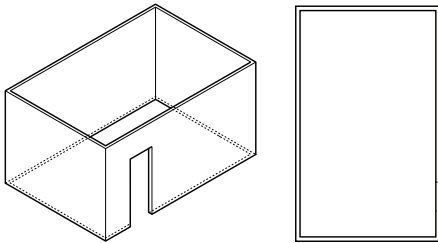

Outdoor Area - Example 1

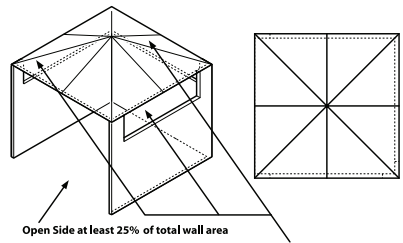

Open Side at least 25% of total wall area

30% or more in total of the remaining wall area is open and unrestricted

Outdoor Area - Example 4

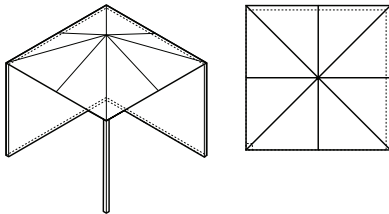

Outdoor Area - Example 2

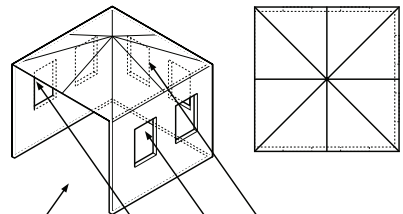

Open Side at least 25% of total wall area

30% or more in total of the remaining wall area is open and unrestricted

Outdoor Area - Example 5

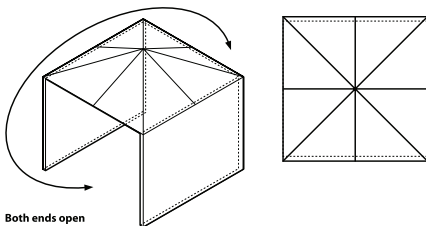

Both ends open

Outdoor Area - Example 3