

**Gasmate**  
the outdoors made easy



# PLATINUM III

## The Gasmate Platinum III Series

Allows you to create your own stunning outdoor cooking and entertaining area



Available at  
**BUNNINGS**  
warehouse

Take This Brochure to the Special Orders Desk to place an order

# PLATINUM III KITCHEN

INCLUDED: GASMATE PLATINUM III BBQ, STORAGE MODULE, SINK MODULE, ROTESSERIE KIT AND VINYL COVER

I/N 3171289  
MODEL NO.  
BQ1080KIT

 #304 GRADE STAINLESS STEEL BBQ AND MODULES

 SUPPLIED FULLY ASSEMBLED FOR QUICK AND EASY INSTALLATION

 INCLUDES ROTISSERIE KIT AND PROTECTIVE VINYL COVER

 FLEXIBLE LAYOUT COMBINATIONS

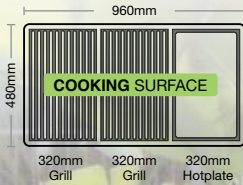

COMPLETE OUTDOOR KITCHEN WITH POWERFUL 6 BURNER BBQ WITH SIDE BURNER, SINK AND STORAGE MODULES WITH BLACK GRANITE BENCH TOPS

BBQ FEATURES FULL SIZE COOKING SURFACE (960mm X 480mm), HOOD WITH VIEWING WINDOW, INTERNAL LIGHTS AND ON CONTROL KNOBS, ELECTRONIC IGNITION, SIDE BURNER AND REAR CERAMIC BURNER

STORAGE MODULE PROVIDES AMPLE BENCH SPACE AND INSIDE THE CABINET THERE ARE 3 SHELVES AND PLENTY OF ROOM TO KEEP THINGS ORGANISED

SINK MODULE HAS WELS RATED HOT AND COLD MIXER TAP THAT CAN BE PLUMBED IN. THE GENEROUS SIZED SINK CAN BE MOUNTED ON EITHER THE LEFT OR RIGHT SIDE OF THE MODULE

ABILITY TO ADD 1 & 2 DOOR FRIDGE AND MATCHING GRANITE TOP (SOLD SEPARATELY)

MATCHING RANGEHOOD AVAILABLE (SOLD SEPARATELY)

DIMENSIONS:  
3130mm (W) X 630mm (D) X 1200mm (H)

AGA CERTIFIED AND SUITABLE FOR NATURAL GAS CONVERSION



Delivery options for kitchen includes a home delivery service to selected areas only. Terms and conditions apply. See team members for further details



# PLATINUM III SERIES

## INDIVIDUAL BBQ'S AND MODULES

### CREATE YOUR OWN ENTERTAINING AREA

The Gasmate Platinum III Series allows you to create your own stunning outdoor cooking and entertaining area. Start with the Platinum III 6 Burner BBQ and add the Platinum III Series Modules that you need. The BBQ and modules can be arranged in any combination, tailor them to suit your own area or budget. You can even add more modules later.

Or buy the Gasmate Platinum III Built-In BBQ to build into your own cabinetry.













There is a stainless steel professional rangehood and bar fridges to choose from, to really finish off your outdoor kitchen.

The possibilities are endless!



# PLATINUM III BBQ

I/N 3171290  
MODEL NO.  
BQ1080

 #304 GRADE STAINLESS STEEL BBQ SUPPLIED FULLY ASSEMBLED	 STAINLESS STEEL FLAME TAMERS FOR EVEN HEAT DISTRIBUTION
 #304 GRADE STAINLESS STEEL HOOD WITH GLASS VIEWING WINDOW	 CERAMIC REAR BURNER FOR HEALTHY ROTISSERIE COOKING
 TEMPERATURE GAUGE AND COOL TOUCH HANDLE	 COMPLETE WITH STAINLESS STEEL WARMING RACK
 TWO CONVENIENT INTERNAL LIGHTS AND BLUE LED'S ON CONTROL KNOBS	 CONVENIENT SLIDE-OUT CYLINDER STORAGE
 ELECTRONIC IGNITION FOR EFFORTLESS LIGHTING	 LOCKING CASTORS
 STAINLESS STEEL BURNERS WITH INDIVIDUAL CONTROLS	 AGA CERTIFIED AND APPROVED FOR NATURAL GAS CONVERSION

- With integrated high output side burner
- Supplied with hose and regulator
- Powerful combined output of 96MJ/h (6 x 11.6MJ/h burners + 15MJ/h side burner + 11.5MJ/h rear burner)
- **1470mm W x 630mm D x 1200mm H**

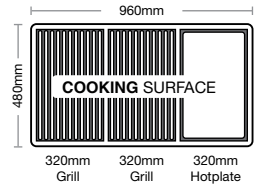

# PLATINUM III BUILT-IN BBQ

I/N 3171291  
MODEL NO.  
BQ1080B

- #304 GRADE STAINLESS STEEL BBQ SUPPLIED FULLY ASSEMBLED
- #304 GRADE STAINLESS STEEL HOOD WITH GLASS VIEWING WINDOW
- TEMPERATURE GAUGE AND COOL TOUCH HANDLE
- CONVENIENT INTERNAL LIGHTS AND BLUE LED ON CONTROL KNOBS
- ELECTRONIC IGNITION FOR EFFORTLESS LIGHTING
- SATIN ENAMEL CAST IRON REVERSIBLE PLATE AND STAINLESS STEEL GRILL
- STAINLESS STEEL BURNERS WITH INDIVIDUAL CONTROLS
- STAINLESS STEEL FLAME TAMERS FOR CONTROLLED HEAT DISTRIBUTION
- CERAMIC REAR BURNER FOR HEALTHY ROTISSERIE COOKING
- COMPLETE WITH STAINLESS STEEL WARMING RACK
- AGA CERTIFIED AND APPROVED FOR NATURAL GAS CONVERSION
- INCLUDES HANGING BRACKETS OR ADJUSTABLE FEET FOR MOUNTING PREFERENCE

- With integrated high output side burner
- Supplied with hose and regulator
- Powerful combined output of 96MJ/h (6 x 11.6MJ/h burners + 15MJ/h side burner + 11.5MJ/h rear burner)
- **1470mm W x 630mm D x 530mm H**

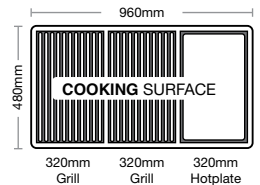

**PLATINUM III  
STORAGE MODULE**

**I/N 3171293  
MODEL NO.  
BQ1082**



STYLISH INTEGRATED  
HANDLES

INCLUDES 3 STORAGE  
SHELVES

LOCKING CASTORS

BLACK GRANITE TOP

Premium #304 grade stainless steel cabinet

- Supplied fully assembled
- 830mm W x 630mm D x 905mm H



BLACK  
GRANITE  
TOP

**PLATINUM III SINK, BIN  
AND STORAGE MODULE**

**I/N 3171292  
MODEL NO.  
BQ1081**

STYLISH INTEGRATED  
HANDLES

OUTDOOR SINK WITH  
MODERN FLICK TAP

LOCKING CASTORS AND  
STRAINING PLUG

BLACK GRANITE TOP

RUBBISH BIN

Premium #304 grade stainless steel cabinet

- **1** Interchangeable sink – top can be moved from left to right depending on your kitchen layout
- WELS Approved Hot and Cold Tap
- Supplied fully assembled
- 830mm W x 630mm D x 905mm H

# FRIDGE TOPS



 PLATINUM III  
2 DOOR BAR FRIDGE TOP

**I/N 3171308**  
MODEL NO.  
**BQ1046**

- 903mm W x 630mm D



 PLATINUM III  
1 DOOR BAR FRIDGE TOP

**I/N 3171307**  
MODEL NO.  
**BQ1045**

- 503mm W x 630mm D

The fridge tops have a stainless steel fascia with black granite top so that the fridge integrates perfectly into your Platinum III Outdoor Kitchen. The fridge top is also supplied with adjustable feet for your fridge to bring the height up to match your Platinum III Outdoor Kitchen.



# COMPLETES THE LOOK OF YOUR PLATINUM III OUTDOOR KITCHEN

FRIDGE TOP MODEL NO. BQ1046 - I/N 3171308

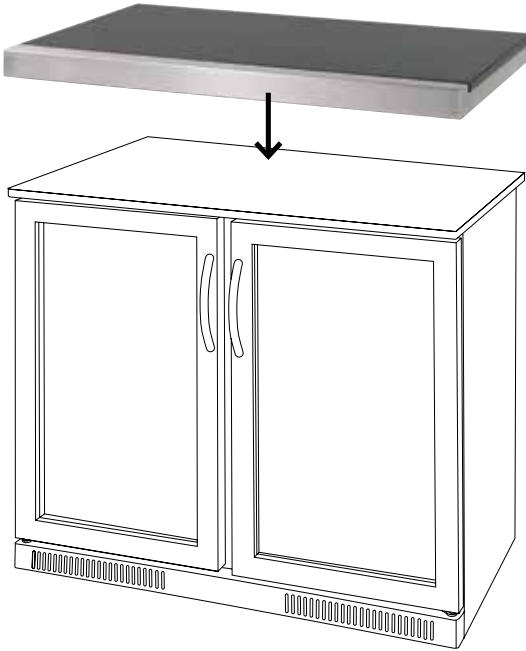

FRIDGE TOP MODEL NO. BQ1045 - I/N 3171307

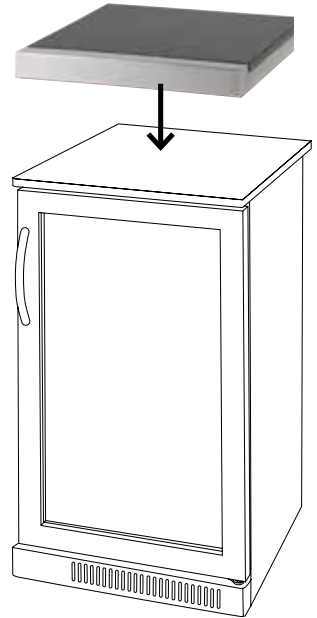

SUITS 2 DOOR FRIDGE I/N 3171042

SUITS 1 DOOR FRIDGE I/N 3171041



Gasmate

2000

# RANGEHOOD



**HIGH POWERED FANS**



**STAINLESS STEEL  
BAFFLE FILTERS**



**LED LIGHTS**

 **WALL MOUNTED 120cm  
RANGEHOOD**

**I/N 3171294  
MODEL NO.  
GRHM**

 **2000m<sup>3</sup>/hr EXTRACTION  
CAPACITY**

 **MARINE GRADE #316  
STAINLESS STEEL**

 **STAINLESS STEEL BAFFLE  
FILTERS DISHWASHER PROOF**

 **INDIVIDUAL 3 SPEED PUSH  
BUTTON FAN CONTROLS**

 **4 X LED LIGHTS, 12V – 1.8W**

 **2 X 1000 WATT MOTORS**



**WALL  
MOUNT**



- 150mm diameter flexible ducting x 2
- Minimum 1200mm from BBQ cooking surface to Rangehood
- Noise level  $\leq$  80 dba
- Weight: 40Kg
- **1200mm W x 800mm D**

# CONTENTS AND DIMENSIONS

- 1 x Rangehood with 2 x 150mm duct adaptors fitted
- 2 x Chimney covers each 400mm high
- 1 x Chimney mounting bracket top
- 2 x Expanding ducts 150mm x 2m

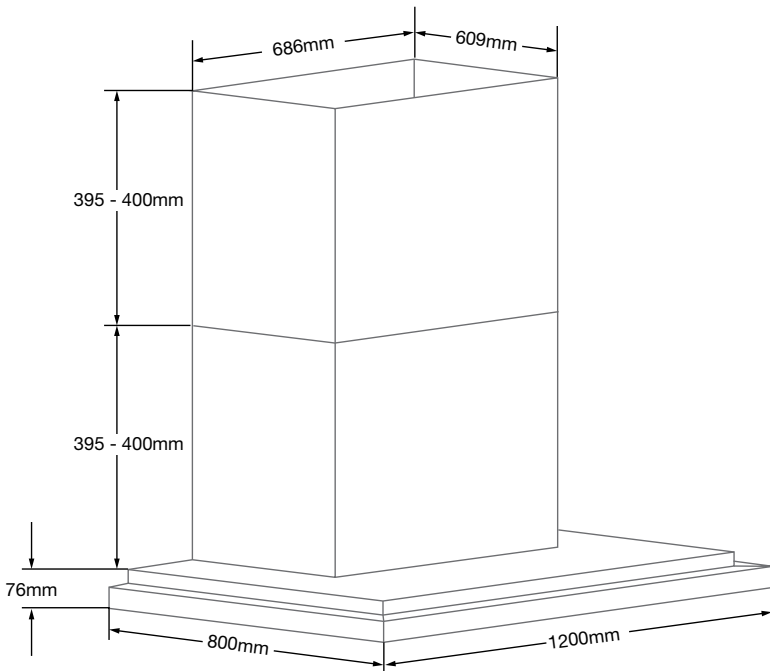

Finish	Marine grade stainless steel #316
Total Height	515mm - Not including flue covers
Height Above Cooking Surface	1200mm - Minimum    1250mm - Maximum
Noise	≤ 90db
Duct Diameter	150mm
Flue Surround	2 at 400mm high
Filters	Stainless steel #304 baffle style

# RANGEHOOD INSTALLATION

Please consider the following before commencing to install your rangehood.

Your rangehood will need to be ducted to ensure it operates and complies with local and national regulations.

## DUCT MOUNTING OPTIONS

You will need some additional parts to complete these installations.

All motors need to be ducted individually and the included expanding duct is 150mm diameter.

\*If installing ducting at the Rear or via the Soffit/Eave please review instruction for the reductions in ducting requirements.

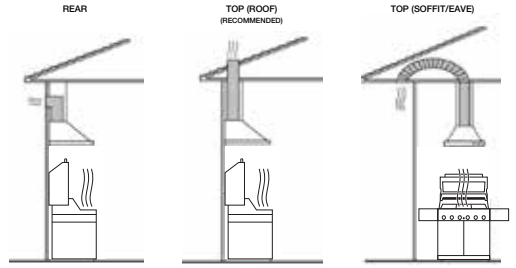

The ideal position of the Rangehood is as follows:

1. Height above cooking surface – 1200mm
2. Distance from cooking surface to rangehood mounting bracket bottom screw hole:

Bracket is part of the rangehood frame - 1582mm

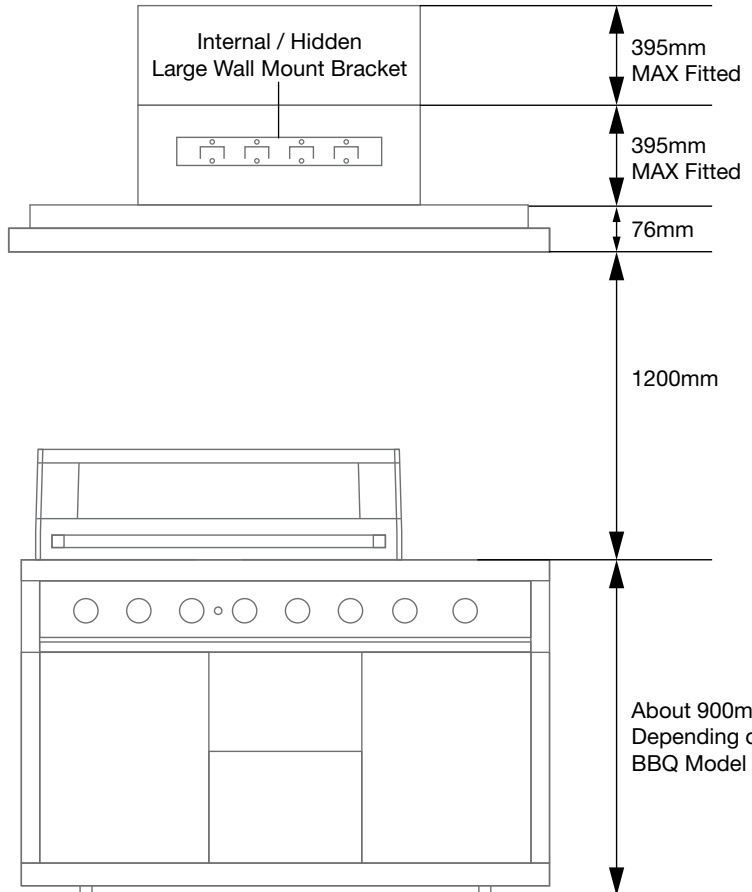

# TECHNICAL DIMENSIONS

## FOR PLUMBING AND CABINETRY



**PLATINUM III SINK DRAIN AND TAP CONNECTION**

**I/N 3171292  
MODEL NO.  
BQ1081**



**PLATINUM III BBQ's  
MINIMUM WALL CLEARANCE**

**BQ1080 +  
BQ1080B +  
BQ1080KIT**

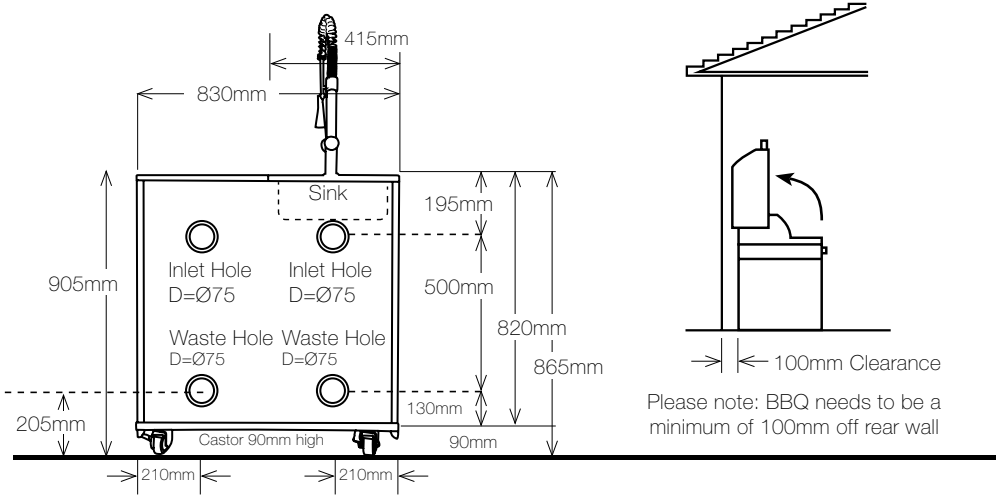

**PLATINUM III  
BUILT IN BBQ**

**I/N 3171291  
MODEL NO.  
BQ1080B**

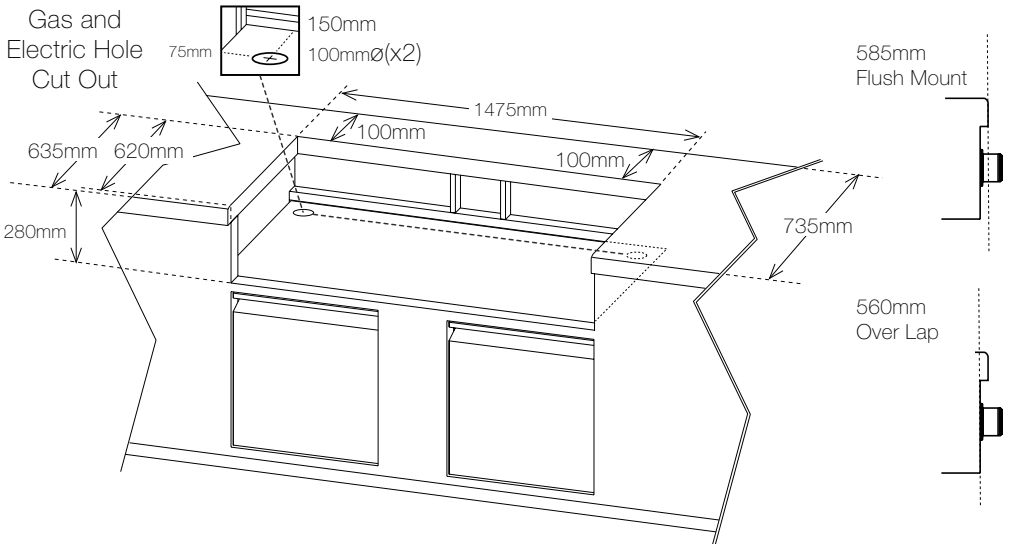





# OUTDOOR USE ONLY

The following situations are considered to provide the natural ventilation required for an outdoor domestic barbecue to be used:

- Four open sides with a roof or overhead cover.
- Four enclosed sides (walls) without a roof or overhead cover.
- Two parallel walls or two walls at right angles to each other with a roof or overhead cover.
- Three walls, with the one open side being at least 25% of the total perimeter and the remaining three walls having an area of 30 per cent or more of unrestricted opening, with a roof or overhead cover.

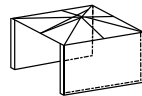

Parallel Walls

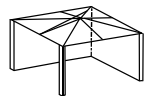

Right Angle Walls

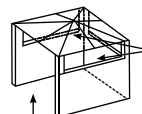

Open side at least 25% of total wall area

30% or more in total of the remaining wall area is open and unrestricted

# ORDER FORM

	Model No.	Fineline	Order Qty.
Platinum III Kitchen	BQ1080KIT	3171289	
<i>Any of the following can also be delivered to your home with your kitchen. For all other products, local delivery charges may apply.</i>			
Platinum III BBQ	BQ1080	3171290	
Platinum III Built In BBQ	BQ1080B	3171291	
Platinum III Sink Module	BQ1081	3171292	
Platinum III Storage Module	BQ1082	3171293	
Rangehood	GRHM	3171294	
Matador 118L Fridge	MF118FVI	3171041	
Matador 228L Fridge	MF228FVI	3171042	
Top to suit Matador 118L Fridge	BQ1045	3171307	
Top to suit Matador 228L Fridge	BQ1046	3171308	
Delivery for 1 to 3 additional items \$22.00	BF13	9920191	
Delivery for 4 to 6 additional items \$44.00	BF46	9920193	
Delivery for 7 to 9 additional items \$66.00	BF79	9920194	

## Home Delivery Order Form

Selected areas only, please confirm DELIVERY post code with team member. Platinum III Kitchen must be part of an order to qualify for home delivery

Name	
Phone Number	
Email Address	
Delivery Address	

**Take This Order Form** to the Special Orders Desk to place an order



45 03411-4

F/L 9931120

Due to continual product development, the product you purchase may differ slightly from the ones shown here. Gasmate® is a registered trademark of Sitro Group Australia Pty. Ltd. [www.gasmate.com.au](http://www.gasmate.com.au)

03457 06/18

Available at  
**BUNNINGS**  
warehouse

Find us on  
**Facebook** 

[www.facebook.com/GasmateAustralia](http://www.facebook.com/GasmateAustralia)